

Thank You

Thank you for choosing MotorGuide® Tour Series. MotorGuide capitalized on many years of experience to provide you with a motor designed to deliver Digital Variable Speed Control and maximum time on the water.

The Tour Series was designed with quality and durability in mind. The all-metal construction provides years of reliability with unmatched control and feel. The stainless steel cables and pulleys allow you to concentrate less on boat control and more on fishing. Couple these mechanics with MotorGuide Digital electronics, and you have one of the most popular trolling motors in the fishing world.

Through the alliance between MotorGuide and Lowrance, we have codeveloped one of the quietest, most accurate transducer integrated trolling motors ever built. The 200/83 kHz transducer provides an accurate sonar plot and a responsive temperature reading. This combination is sure to improve your fishing, season after season.

Remember to keep your receipt and immediately register your trolling motor. A warranty card is enclosed or you can complete registration on the internet at www.motorguide.com. At MotorGuide, we believe there are some things you should Never Stop doing.

**NEVER STOP LEARNING, NEVER STOP IMPROVING,
AND NEVER, EVER STOP FISHING.**

Warranty Message

The product you purchased comes with a **Limited Warranty** from MotorGuide. The terms of the policy are set forth in the **Warranty Information** section of this manual. The policy statement contains a description of the duration of coverage, **important disclaimers and limitations of damages**, and other related information. Please review this important information.

The description and specifications contained herein were in effect at the time this manual was approved for printing. MotorGuide, whose policy is one of continued improvement, reserves the right to discontinue models at any time, to change specifications, designs, methods, or procedures without notice and without incurring obligation.

MotorGuide, Lowell, Michigan U.S.A.

Litho in U.S.A.

© 2010, Mercury Marine. All Rights Reserved. Reproduction in whole or in part without permission is prohibited.

Safari is a trademark of Brunswick Corporation.

Mercury, Mercury Marine, MerCruiser, Mercury MerCruiser, Mercury Racing, MotorGuide, Gator, Machete, Mercury Precision Parts, Mercury Propellers, Mariner, Quicksilver, #1 On The Water, Alpha, Bravo, Bravo Two, Pro Max, OptiMax, Sport-Jet, K-Planes, MerCathode, SmartCraft, Total Command, VesselView, Zero Effort, Zeus, M with Waves logo, Mercury with Waves logo, and SmartCraft logo are all registered trademarks of Brunswick Corporation. Mercury Product Protection logo is a registered service mark of Brunswick Corporation.

Lowrance is a registered trademark of Navico Inc. Garmin is a registered trademark of Garmin Ltd. Vexilar is a registered trademark of Vexilar, Inc.

Warranty Information

MotorGuide Limited Warranty.....	1
----------------------------------	---

General Information

Component Identification.....	5
Recording Serial Number.....	7
Boater's Responsibilities.....	7
Safe Boating Suggestions.....	8

Product Installation

Tour Gator 21 Spring Mount Installation.....	9
Foot Pedal Permanent Installation.....	10
Standard Practices and Procedures.....	11
Battery Recommendations.....	11
Battery Precautions.....	12
Wire and Cable Routing.....	12
Establishing A Common Ground.....	13
Wire Color Code Abbreviations.....	13
Battery Connection.....	13

Trolling Motor Operation

Installing and Removing the Motor.....	17
Connecting the Sonar Display to Motor.....	17
Stowing and Deploying the Trolling Motor.....	18
Adjusting the Motor Depth.....	20
Foot Pedal Operation.....	22

Maintenance and Storage

Trolling Motor Care.....	24
Inspection and Maintenance Schedule.....	24
Storage Preparation.....	25
Battery Inspection.....	26
Propeller Replacement.....	26
Foot Pedal Cable Tension Adjustment.....	27

Owner Service Assistance

Troubleshooting.....	29
Service Assistance.....	32
Mercury Marine Service Offices.....	33

WARRANTY INFORMATION

MotorGuide Limited Warranty

KEEP YOUR ORIGINAL PURCHASE RECEIPT OR BILL OF SALE.

1. For recreational use customers, MotorGuide electric trolling motors are warranted to the original retail purchaser to be free from defects in material or workmanship for two (2) years.
2. To obtain warranty service, the purchaser should deliver or return the unit (postage prepaid and insured) to any authorized MotorGuide service dealer. DO NOT RETURN TO PLACE OF PURCHASE unless they are an authorized service center. Products returned by mail should be carefully packaged and include a note describing the nature of the problem and/or service requested, customer address, and phone number. A copy of the receipt, Bill of Sale, registration verification or other proof of purchase is required with the return of the product for warranty consideration. Warranty claims will not be accepted without presentation of purchase receipt for trolling motor, other verification of registration, or Bill of Sale for boat package.
3. MotorGuide, at its discretion, will repair or replace items covered under the terms of this warranty. Neither MotorGuide nor MotorGuide service dealers are responsible for damages to MotorGuide products due to repairs performed by anyone other than an authorized MotorGuide service dealer. Neither MotorGuide nor Mercury Marine is responsible for failure or damage caused by improper installation, setup, preparation, or previous service or repair errors.

WARRANTY INFORMATION

4. For commercial use and government use customers, MotorGuide electric trolling motors are warranted to the original retail purchaser to be free from defects in material or workmanship for one (1) year. Commercial use is defined as any work or employment-related use of the product, or any use of the product which generates income, for any part of the warranty period, even if the product is only occasionally used for such purpose such as Rental Fleets, Guides, Fish Camps or similar operations. Warranty is not transferable to any subsequent purchaser. The Mercury Product Protection plan is not available to commercial use or government use customers.
5. Warranty coverage is available to customers that purchase from an authorized dealer or retailer that is authorized by MotorGuide Marine to distribute the product in the country in which the sale occurred. Warranty coverage and duration varies by the country in which the owner resides. This warranty applies to MotorGuide trolling motors sold and used in the United States. This Limited Warranty begins on the date the product is first sold to a purchaser or the date on which the product is first put into service, whichever occurs first. MotorGuide accessories are covered by this Limited Warranty for a coverage period of one (1) year from the date of retail sale. The repair or replacement of parts, or the performance of service under this warranty, does not extend the life of this warranty beyond its original expiration date. Promotional warranties are not included in this statement and coverage may vary by promotion. Product either sold or put into service more than six years from date of manufacture is excluded from warranty coverage.

WARRANTY INFORMATION

6. This warranty does not apply to normal worn parts, for example, worn cables, adjustments, or product damage due to; 1) neglect, lack of maintenance, accident, abnormal operation or improper installation or service; 2) abuse, such as, bent metal columns, bent armature shafts, broken control cables, etc., accidents, modifications, misuse, excessive wear or damage caused by an owner's failure to provide reasonable and necessary installation or care; 3) use of an accessory or part not manufactured by MotorGuide or Mercury; 4) alteration or removal of parts; 5) opening the lower unit (motor) by anyone other than an authorized MotorGuide service center will void this warranty.
7. We reserve the right to improve the design of any trolling motor without assuming any obligation to modify any trolling motor previously manufactured.
8. All serialized "Service-Repair" trolling motors receive a one (1) year warranty. Nonserialized "Service-Repair" electric trolling motors are NOT warranted. "Service-Repair" motor denotes a trolling motor sold by MotorGuide that may be used but has been inspected and may have had minor repairs. Original retail purchaser of a "Service-Repair" motor is the first purchaser of the motor after it is denoted as "Service-Repair." "Service-Repair" motors have a blue sticker on the battery cable and box denoting "Manufacturer Certified Service-Repair Motor."
9. This warranty will not apply to 1) haul-out, launch, towing and storage, transportation charges and/or travel time, telephone or rental charges of any type, inconvenience, or loss of time or income, or other consequential damages; or 2) removal or replacement of boat partitions or material because of boat design for necessary access to the Product; or 3) disconnection and reconnection of hard-wired trolling motors.
10. **TERMINATION OF COVERAGE:** Warranty coverage may be terminated for repossessed product, or product purchased at auction, from a salvage yard, from a liquidator, from an insurance company, from unauthorized marine dealers or boatbuilders, or other third party entities.

WARRANTY INFORMATION

11. ALL INCIDENTAL OR CONSEQUENTIAL DAMAGES ARE EXCLUDED FROM THIS WARRANTY, WARRANTIES OF MERCHANTABILITY AND FITNESS ARE EXCLUDED FROM THIS WARRANTY, IMPLIED WARRANTIES ARE LIMITED TO THE LIFE OF THIS WARRANTY. SOME STATES DO NOT ALLOW LIMITATIONS ON HOW LONG AN IMPLIED WARRANTY LASTS OR THE EXCLUSION OR LIMITATION OF INCIDENTAL OR CONSEQUENTIAL DAMAGES, SO THE ABOVE LIMITATIONS OR EXCLUSIONS MAY NOT APPLY TO YOU. THIS WARRANTY GIVES YOU SPECIFIC LEGAL RIGHTS, AND YOU MAY ALSO HAVE OTHER LEGAL RIGHTS WHICH MAY VARY FROM STATE TO STATE.

For your records:

Model Number _____

Serial Number _____

GENERAL INFORMATION

Component Identification

TOUR LOWRANCE SONAR SERIES

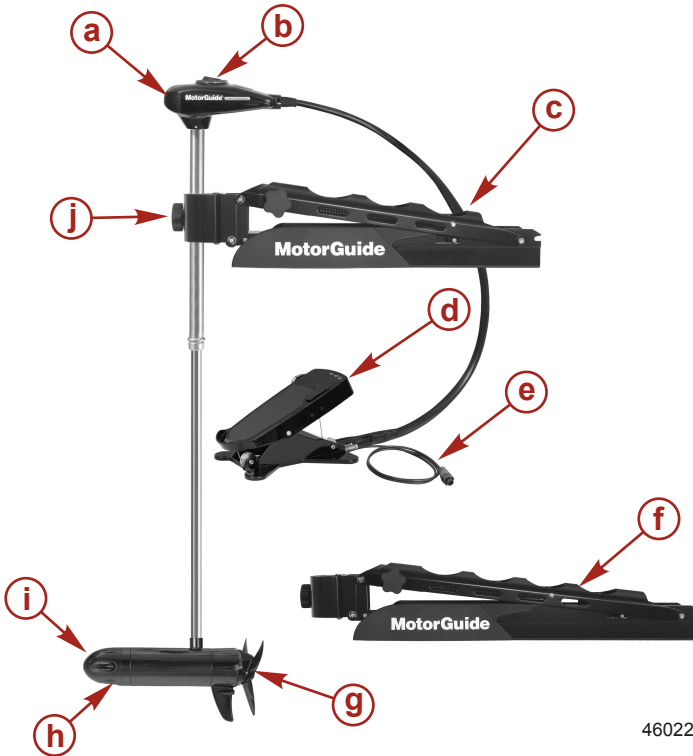

46022

- a** - Top housing
- b** - Directional indicator
- c** - Tour Gator 21 Spring mount
- d** - Foot pedal
- e** - Lowrance connector cable
- f** - Tour Gator 24 Spring mount
- g** - Propeller
- h** - Tour Sonar lower unit
- i** - Nose cone
- j** - Door assembly

GENERAL INFORMATION

TOUR SERIES

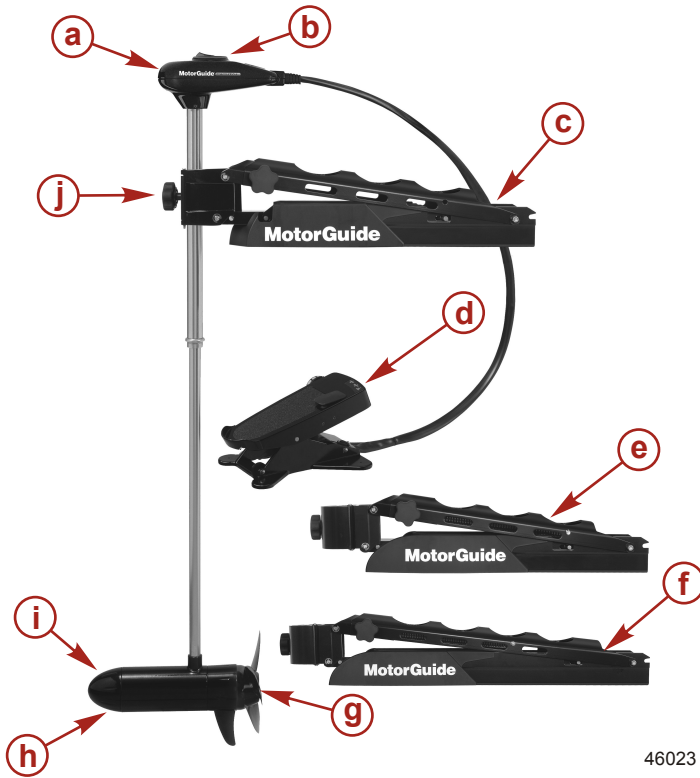

46023

- a** - Top housing
- b** - Directional indicator
- c** - Gator 20.8 Breakaway mount
- d** - Foot pedal
- e** - Tour Gator 21 Spring mount
- f** - Tour Gator 24 Spring mount
- g** - Propeller
- h** - Lower unit
- i** - Nose cone
- j** - Door assembly

GENERAL INFORMATION

Recording Serial Number

Record the serial number for future reference. For warranty purposes, complete the enclosed warranty card or register your trolling motor at www.motorguide.com.

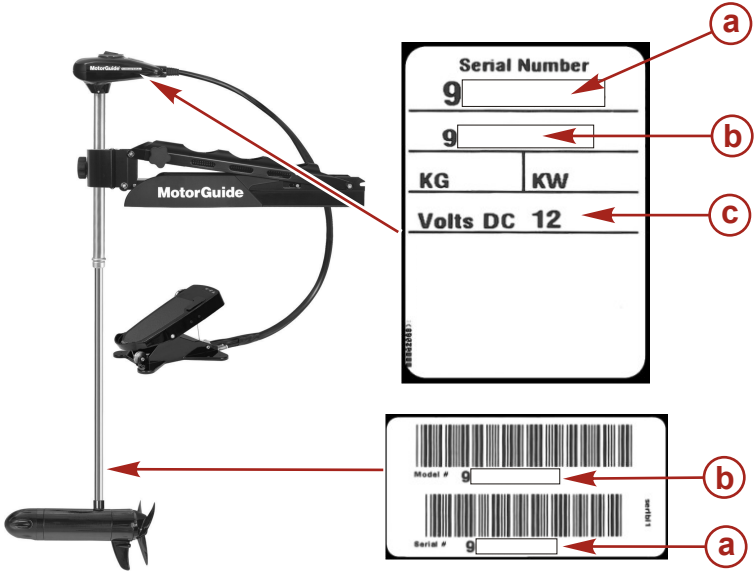

45938

- a** - Serial number
- b** - Model identification number
- c** - Voltage

Boater's Responsibilities

The operator (driver) is responsible for the correct and safe operation of the boat and safety of its occupants and general public. It is strongly recommended that each operator (driver) read and understand this entire manual before operating the trolling motor.

Be sure at least one additional person on board is instructed in the basic operation of the trolling motor in case the driver is unable to operate the boat.

GENERAL INFORMATION

Safe Boating Suggestions

In order to safely enjoy the waterways, familiarize yourself with local and other governmental boating regulations and restrictions, and consider the following suggestions.

Use flotation devices. It is the law to have an approved personal flotation device of suitable size for each person aboard and have it readily accessible.

Do not overload your boat. Most boats are rated and certified for maximum load (weight) capacities, refer to your boat capacity plate. If in doubt, contact your dealer or the boat's manufacturer.

Perform safety checks and required maintenance. Follow a regular schedule and ensure all repairs are made properly.

Never be under the influence of alcohol or drugs while boating (it is the law). Alcohol or drug use impairs your judgment and greatly reduces your ability to react quickly.

Passenger boarding. Stop the trolling motor whenever passengers are boarding or unloading.

Be alert. The operator of the boat is responsible by law to maintain a proper lookout by sight and hearing. The operator must have an unobstructed view particularly to the front. No passengers, load, or fishing seats should block the operators view when operating the boat.

Underwater hazards. Reduce speed and proceed with caution whenever navigating in shallow water.

Tripping hazards. To avoid a trip hazard, route all cables and wiring neatly and out of the way.

Report accidents. Boat operators are required by law to file a Boating Accident Report with their state boating law enforcement agency when their boat is involved in certain boating accidents. A boating accident must be reported if 1) there is loss of life or probable loss of life, 2) there is personal injury requiring medical treatment beyond first aid, 3) there is damage to boats or other property where the damage value exceeds \$500.00 or 4) there is complete loss of the boat. Seek further assistance from local law enforcement.

PRODUCT INSTALLATION

Tour Gator 21 Spring Mount Installation

NOTE: This bow mount installation procedure applies to the Gator 20.8 Breakaway mount (pictured), the Tour Gator 21 Spring mount, and the Tour Gator 24 Spring XL mount.

IMPORTANT: Choose an area on the deck that provides 7.6 cm (3 in.) clearance from the bow of the boat for all motor positions, including deployed and stowed positions.

1. Select an appropriate area on the deck of the boat to install the mount. Ensure the forward mounting screws will not penetrate the hull.

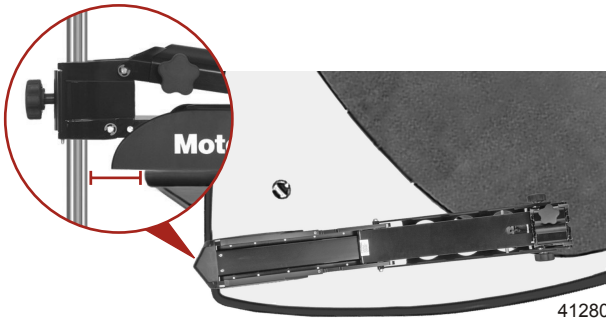

Mount on deck with a 7.6 cm (3 in.) clearance

2. Place the bow mount base on the surface of the boat deck. Use the bow mount base as a template to mark the locations of the front mounting holes in the plastic decket and the rear mounting holes on the mount base.

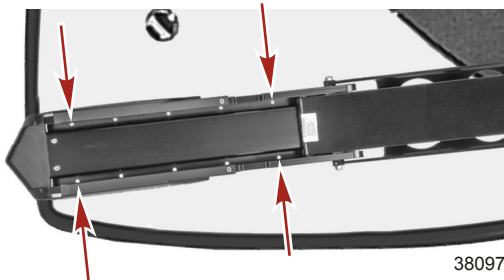

Mount base mounting holes

PRODUCT INSTALLATION

3. Drill the mounting holes with a 7 mm (1/4 in.) diameter drill bit. Remove any debris.
4. Redrill each mounting hole with a 13 mm (1/2 in.) diameter drill bit.

IMPORTANT: Countersink the holes on fiberglass boats to prevent cracking.

5. Insert the rubber mounting isolators into the drilled holes. Position the isolators in line with the mount base with the wider side toward the outside of the mount bracket.



6. Place the mount bracket on the isolators and align the holes. Install the two long screws into the front mounting holes and the two short screws into the rear mounting holes. Tighten all of the mounting screws securely with a Phillips screwdriver. Do not tighten the mounting screws with an electric driver.

IMPORTANT: The bracket must lay flush against the isolators before being bolted to the deck or the mount will bind, making it difficult or impossible to unlatch.

7. When the bracket is installed, it should fasten securely and evenly with the latch pins and release with a light, quick, pull of the rope handle.

Foot Pedal Permanent Installation

NOTE: *It is not necessary to permanently mount the foot pedal to operate the trolling motor.*

1. Select an appropriate area on the deck of the boat to install the foot pedal.
2. Place the foot pedal on the surface of the boat deck. Use the foot pedal as a template to mark the locations of the mounting holes on the boat deck.

PRODUCT INSTALLATION

3. Drill the mounting holes with a 3 mm (7/64 in.) diameter drill bit. Remove any debris.
4. Use four 8 x 2 in. stainless steel screws to secure the foot pedal base to the boat deck.



41447

Foot pedal mounting holes and screws

Standard Practices and Procedures

- Do not use the main engine battery to power the trolling motor.
- Disconnect the trolling motor from the battery when charging and after each use.
- Route the trolling motor wires on the opposite side of the boat from other miscellaneous boat wiring.
- Connect boat accessories directly to the main engine battery.

Battery Recommendations

- Use a 12 volt, deep cycle marine battery. Refer to **Battery Connection**.
- Install a 50 amp manual reset circuit breaker in line with the trolling motor positive leads within 180 cm (72 in.) of the batteries.
- Use 13 mm (6 gauge) battery cables if extending the existing wire 3 m (10 ft) beyond the standard battery cable supplied with the product.

PRODUCT INSTALLATION

Recommended MotorGuide Accessory Description	Part Number
50 Amp Manual Reset Circuit Breaker	MM5870

Battery Precautions

WARNING

An operating or charging battery produces gas that can ignite and explode, spraying out sulfuric acid, which can cause severe burns. Ventilate the area around the battery and wear protective equipment when handling or servicing batteries.

When charging batteries, an explosive gas mixture forms in each cell. Part of this gas escapes through holes in the vent plugs and may form an explosive atmosphere around the battery if ventilation is poor. This explosive gas may remain in or around the battery for several hours after it has been charged. Sparks or flames can ignite this gas and cause an internal explosion, which may shatter the battery.

The following precautions should be observed to prevent an explosion:

1. Do not smoke near batteries being charged or which have been charged very recently.
2. Do not break live circuits at terminals of batteries, because a spark usually occurs at the point where a live circuit is broken. Always be careful when connecting or disconnecting cable clamps on chargers. Poor connections are a common cause of electrical arcs which cause explosions.
3. Do not reverse polarity of battery terminal to cable connections.

Wire and Cable Routing

- Route the trolling motor wires on the opposite side of the boat from other boat wiring.
- Accessories should be connected directly to the main engine battery.

PRODUCT INSTALLATION

Establishing A Common Ground

Connect the trolling motor and main engine accessories to the same negative ground terminal. A common ground connection increases sonar sensitivity and improves the sonar display. Not establishing a common ground may cause severe corrosion or electrolysis.

Wire Color Code Abbreviations

Wire Color Abbreviations				
BLK	Black		BLU	Blue
BRN	Brown		GRY	Gray
GRN	Green		ORN or ORG	Orange
PNK	Pink		PPL or PUR	Purple
RED	Red		TAN	Tan
WHT	White		YEL	Yellow
LT or LIT	Light		DK or DRK	Dark

Battery Connection

CAUTION

Disconnecting or connecting the battery cables in the incorrect order can cause injury from electrical shock or can damage the electrical system. Always disconnect the negative (-) battery cable first and connect it last.

Recommended MotorGuide Accessory Description	Part Number
50 Amp Manual Reset Circuit Breaker	MM5870

PRODUCT INSTALLATION

12 VOLT BATTERY CONNECTION

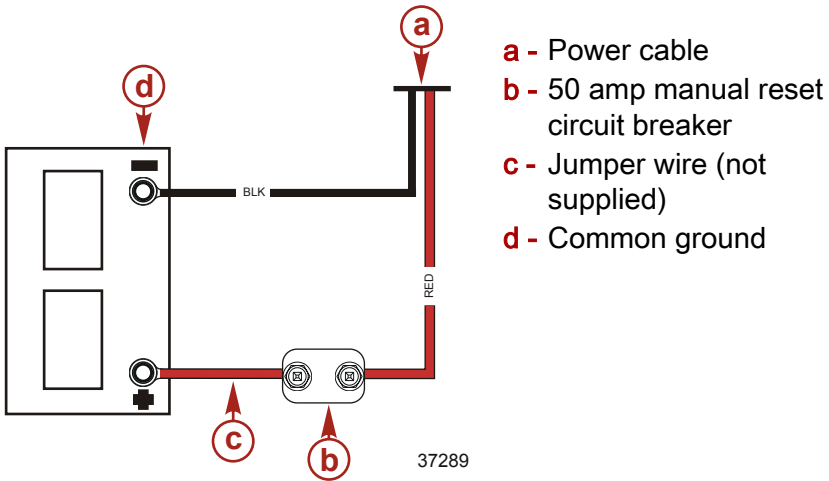

1. Install a 50 amp manual reset circuit breaker in line with the positive lead.
2. Connect the red battery lead from the power cable circuit breaker to the positive (+) battery post.
3. Connect the black battery lead from the power cable to the negative (-) battery post.

PRODUCT INSTALLATION

24 VOLT BATTERY CONNECTION

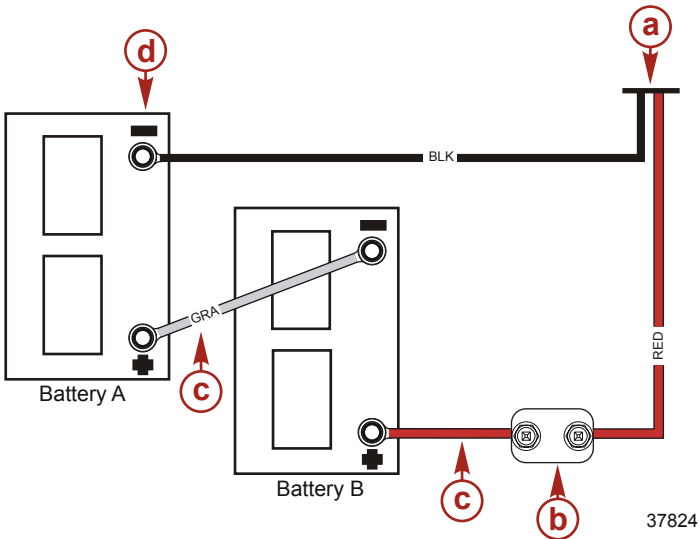

- a** - Power cable
- b** - 50 amp manual reset circuit breaker
- c** - Jumper wire (not supplied)
- d** - Common ground

1. Install a 50 amp manual reset circuit breaker in line with the positive lead.
2. Connect the red battery lead from the power cable circuit breaker to the positive (+) post on battery B.
3. Connect the black battery lead from the power cable to the negative (-) post on battery A.
4. Connect the jumper wire (not supplied) between the negative (-) post on battery B to the positive (+) post on battery A.

PRODUCT INSTALLATION

36 VOLT BATTERY CONNECTION

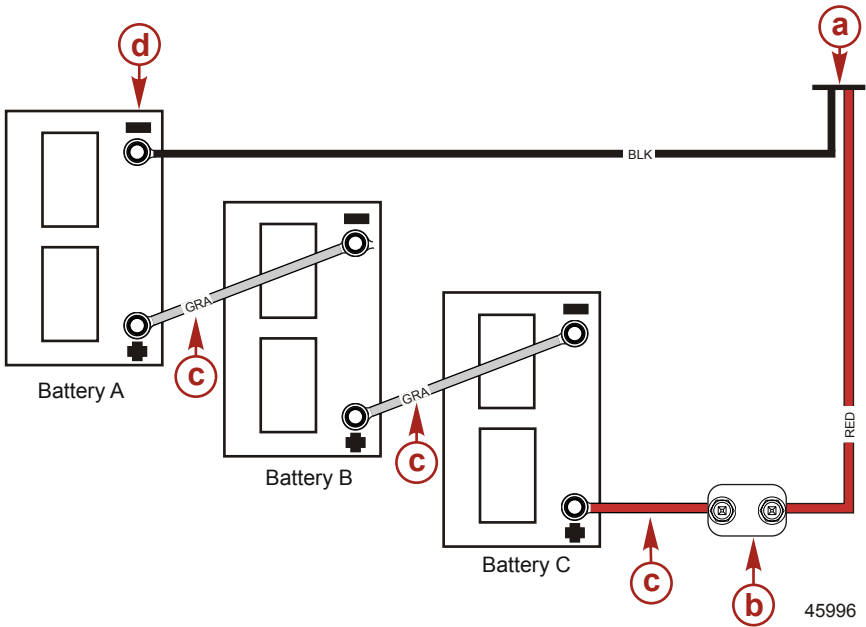

- a** - Power cable
- b** - 50 amp manual reset circuit breaker
- c** - Jumper wire (not supplied)
- d** - Common ground

1. Install a 50 amp manual reset circuit breaker in line with the positive lead.
2. Connect the red battery lead from the power cable circuit breaker to the positive (+) post on battery C.
3. Connect the black battery lead from the power cable to the negative (-) post on battery A.
4. Connect a jumper wire (not supplied) between the negative (-) post on battery C to the positive (+) post on battery B.
5. Connect a second jumper wire (not supplied) between the negative (-) post on battery B to the positive (+) post on battery A.

TROLLING MOTOR OPERATION

Installing and Removing the Motor

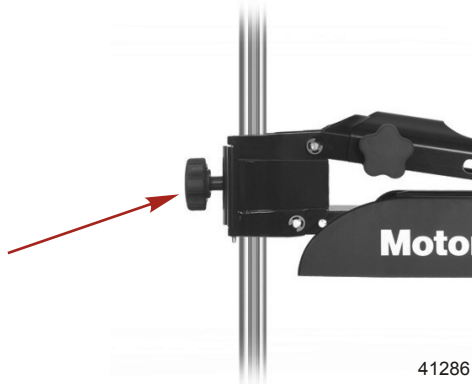

Bracket knob

1. To install the motor to the bow mount, turn the bracket knob counterclockwise to loosen and open the bracket door.
2. Place the motor column into the bracket and close the door.
3. Turn the bracket knob clockwise to tighten the motor column in the bracket.

REMOVING THE MOTOR

1. To remove the motor from the bow mount, turn the bracket knob counterclockwise to loosen and open the bracket door.
2. Remove the motor column from the bracket and close the door.

Connecting the Sonar Display to Motor

NOTE: This sonar display connection procedure applies to the Tour Series motors that offer built-in 200/83 kHz sonar transducers compatible with Eagle®, Garmin®, Humminbird®, Lowrance®, and Vexilar® brand sonar displays. Tour sonar models connect with Lowrance 7 pin sonar units. For compatibility with other sonar units, refer to www.motorguide.com.

TROLLING MOTOR OPERATION

Match the cable connector to the sonar port on the back of the sonar display. Power up the unit to ensure the sonar cable is connected securely.

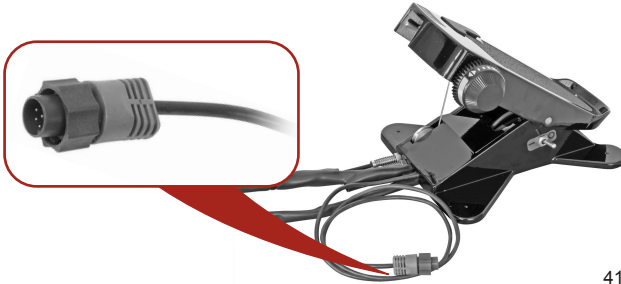

Lowrance 7 pin sonar connector

41478

Stowing and Deploying the Trolling Motor

⚠ WARNING

Rotating propellers can cause serious injury or death. Never start or operate the motor out of water.

⚠ CAUTION

Moving parts, such as hinges and pivot points, can cause serious injury. Keep away from moving parts when stowing, deploying, or tilting the motor.

NOTE: The bow mount stowing and deploying procedures apply to the Gator 20.8 Breakaway mount (pictured), Tour Gator 21 Spring mount, and Tour Gator 24 Spring mount.

STOWING THE TROLLING MOTOR

NOTE: Secure trolling motors with a trolling motor tie-down strap (not included) on all mounts.

Recommended MotorGuide Accessory Description	Part Number
Trolling Motor Tie-Down Strap	MGA507A1

1. Firmly grasp the mount rope handle.
2. Snap the mount rope handle to disengage the lockslide pin.

TROLLING MOTOR OPERATION

3. Continue to pull the mount rope handle to raise the lower unit onto the mount.



Mount rope

IMPORTANT: Gently raise the trolling motor out of the water. Do not release the mount rope handle until the lockslide pin is engaged.

4. Once the motor is in the stow position, the lockslide pin engages to secure the trolling motor.

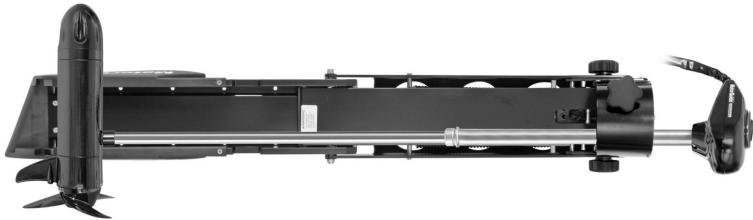

Tour stowed

DEPLOYING THE TROLLING MOTOR

1. Firmly grasp the mount rope handle.
2. Snap the mount rope handle to disengage the lockslide pin.

TROLLING MOTOR OPERATION

3. Continue to pull the mount rope handle to lower the trolling motor into the water.

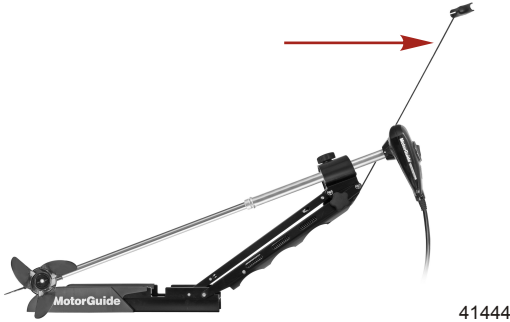

Mount rope

4. Once the motor is in the deployed position, the lockslide pin will engage to secure the trolling motor.



Deployed position

Adjusting the Motor Depth

CAUTION

Avoid possible serious injury from dropping the motor when adjusting the motor depth. Firmly grasp the motor shaft with one hand when raising or lowering the motor.

TROLLING MOTOR OPERATION

Adjust the depth of the motor to improve the trolling motor performance in various water depths.

IMPORTANT: When adjusting the motor depth, ensure the lower unit is fully submerged a minimum of 15 cm (6 in.) to avoid propeller cavitation.

1. Firmly grasp the column with one hand while loosening the bracket knob so the column moves freely.



2. Raise or lower to the desired depth.
3. Tighten the bracket knob to secure the column.
4. Adjust the breakaway knobs on the sides of the mount so the motor will breakaway if it encounters underwater obstacles.



Breakaway knobs

TROLLING MOTOR OPERATION

Foot Pedal Operation

WARNING

Rotating propellers can cause serious injury or death. Never start or operate the motor out of water.

DIRECTION CONTROL

Pivot the foot pedal heel-down to steer left and toe-down to steer right. To operate the motor in reverse, continue to press all the way down on the foot pedal in either operation. The 400° steering range allows the operator to point the motor past 360° from both the left and right side.

The directional indicator on the top of the motor corresponds to the position of the lower unit.

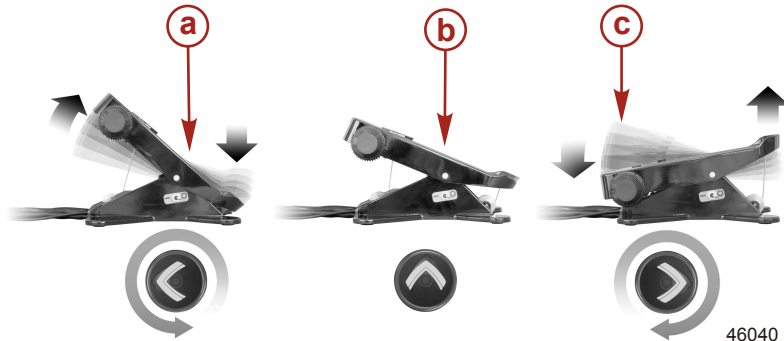

- a** - Heel-down position – left turn
- b** - Center detent position – straight
- c** - Toe-down position – right turn

SPEED CONTROL

Use the three-position toggle switch to operate the motor at any given speed.

1. Constant on - motor runs continuously on the selected speed without the use of the momentary button.
2. Momentary - motor runs continuously on the selected speed with the momentary button depressed.

TROLLING MOTOR OPERATION

3. High-bypass - motor runs continuously on full speed (bypassing the speed setting) with the momentary button depressed.

Control the speed of the motor by adjusting the speed control knob on the foot pedal. Use the momentary switch when operating the trolling motor in momentary or high-bypass operation.

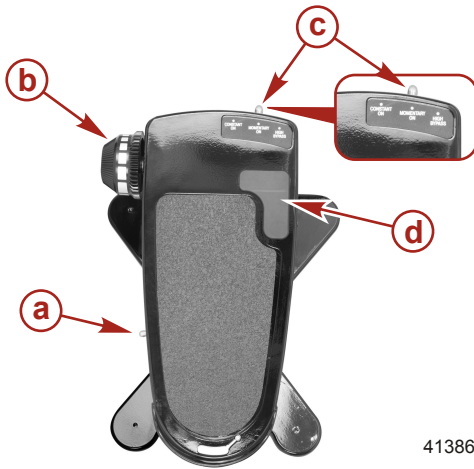

- a** - On-off toggle switch
- b** - Speed control knob
- c** - Three-position toggle switch
- d** - Momentary button

41386

Use the on-off toggle switch to power the motor on and off.

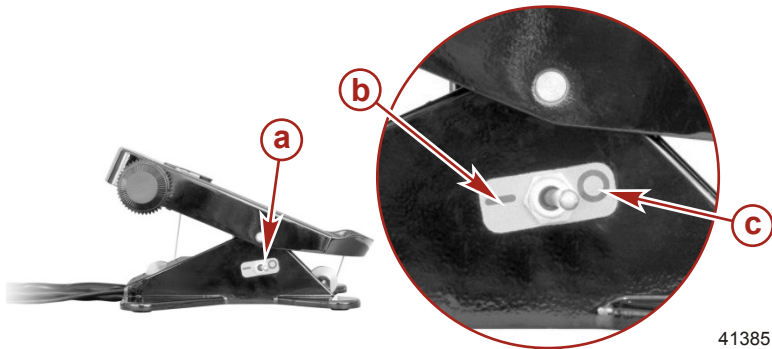

41385

- a** - On-off toggle switch
- b** - Off position
- c** - On position

MAINTENANCE AND STORAGE

Trolling Motor Care

To keep your trolling motor in the best operating condition and retain its dependability, your trolling motor must receive periodic inspections and maintenance. Keep it maintained properly to ensure the safety of you and your passengers.

WARNING

Neglecting to inspect, maintain, or repair your trolling motor can result in product damage or serious injury or death. Do not perform maintenance or service on your trolling motor if you are not familiar with the correct service and safety procedures.

Record all maintenance performed and save maintenance work orders and receipts.

SELECTING REPLACEMENT PARTS

Use only original MotorGuide replacement parts.

Inspection and Maintenance Schedule

BEFORE EACH USE

- Inspect for loose or corroded wiring connections.
- Check the tightness of the battery lead connections.
- Check the tightness of the propeller nut.
- Check the propeller blades for damage.

AFTER EACH USE

- Disconnect the battery cables from the power source or unplug the motor from the boat.
- After each use, check each side of the propeller and propeller shaft for debris such as weeds and fishing line. Remove all debris.
- Check the tightness of the propeller nut.
- Rinse the trolling motor with clean water to remove dirt and dust that may scratch the surface.

MAINTENANCE AND STORAGE

EVERY 100 HOURS OF USE OR ANNUALLY

- Periodically lubricate all the pivot points with a nonaerosol, nonsolvent based lubricant.

IMPORTANT: Never use an aerosol lubricant to grease or oil any part of the unit. Many aerosol lubricants contain harmful propellants that can cause damage to various parts of the trolling motor.

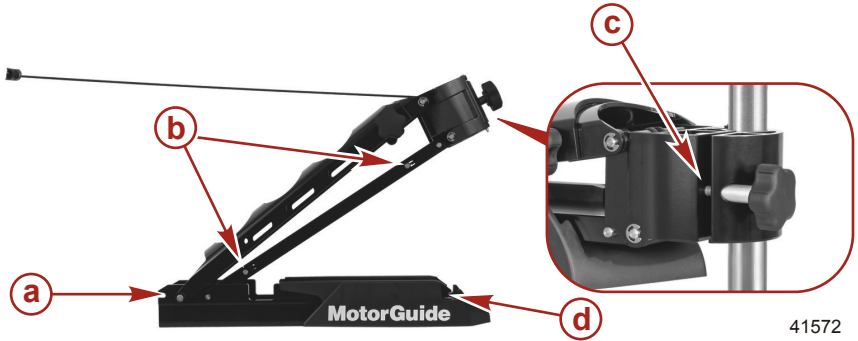

Pivot points

- a** - Rear deck channel grooves
- b** - Lockslide pin
- c** - Door knob shaft
- d** - Forward deck channel grooves

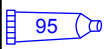
Tube Ref No.	Description	Where Used	Part No.
 95	2-4-C with Teflon	Pivot points	92-802859A 1

- Check the tightness of bolts, nuts, and other fasteners.
- Inspect the battery. Refer to **Battery Inspection**.

Storage Preparation

The major consideration in preparing your trolling motor for storage is to protect it from corrosion and damage caused by freezing of trapped water.

MAINTENANCE AND STORAGE

Refer to the **Maintenance—Inspection and Maintenance Schedule** section and complete the appropriate care instructions to prepare your trolling motor for storage. Store the trolling motor in a dry location where it will not be affected by temperatures below $-29\text{ }^{\circ}\text{C}$ ($-20\text{ }^{\circ}\text{F}$).

IMPORTANT: Trolling motors stored in temperatures below $0\text{ }^{\circ}\text{C}$ ($32\text{ }^{\circ}\text{F}$) should be operated slowly for a minimum of 15 minutes before going above 30% operation.

Battery Inspection

The battery should be inspected at periodic intervals to ensure proper trolling motor operation.

IMPORTANT: Read the safety and maintenance instructions which accompany your battery.

1. Ensure that the battery is secured to the vessel.
2. Ensure that the battery cable terminals are clean, tight, and correctly installed. For installation instructions, refer to **Battery Connection**.
3. Ensure that the battery is equipped with a battery box to prevent accidental shorting of the battery terminals.

Propeller Replacement

WARNING

Performing service or maintenance without first disconnecting the battery can cause product damage, personal injury, or death due to fire, explosion, electrical shock, or unexpected motor starting. Always disconnect the battery cables from the battery before maintaining, servicing, installing, or removing motor components.

REMOVING THE PROPELLER

1. Disconnect the battery cables from the power source.
2. While holding the propeller blade with one hand, use a propeller wrench or pliers to remove the propeller nut.

MAINTENANCE AND STORAGE

IMPORTANT: If the propeller cannot be removed easily, hold one blade and use a rubber mallet to lightly tap the backside of the opposite blade. If the propeller cannot be removed, refer to Troubleshooting.

NOTE: If the propeller pin is bent, replace the propeller pin.

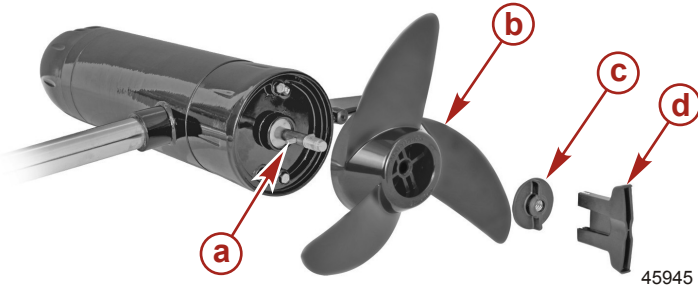

- a** - Propeller pin
- b** - Propeller
- c** - Propeller nut
- d** - Propeller wrench

Recommended MotorGuide Accessory Description	Part Number
MotorGuide Prop Wrench Kit	MGA050B6

INSTALLING THE PROPELLER

1. Rotate the motor shaft to insert the propeller pin horizontally.
2. Install the propeller onto the motor shaft by engaging the propeller onto the propeller pin.
3. Install the propeller nut. Tighten securely.
4. Use a MotorGuide propeller wrench or pliers to tighten the propeller nut another $\frac{1}{4}$ turn.

Foot Pedal Cable Tension Adjustment

The foot pedal cable tension adjustment is correct when the exposed number of threads on the tension adjustment shafts are approximately the same and the amount of deflection of the long exposed foot pedal cable under a 9.1 kilogram force (20 lbf) pull is approximately 19 mm (3/4 in.).

MAINTENANCE AND STORAGE

To check for proper foot pedal cable tension, apply a 9.1 kilogram force (20 lbf) pull at the center of the long exposed foot pedal cable. The amount of deflection of the cable should be approximately 19 mm (3/4 in.). If the deflection is not correct, use a 13 mm (1/2 in.) wrench to adjust the cable tension nuts to obtain the proper deflection.

IMPORTANT: Equal adjustments should be made to each cable tension nut to maintain an equal right and left steering radius with the foot pedal.

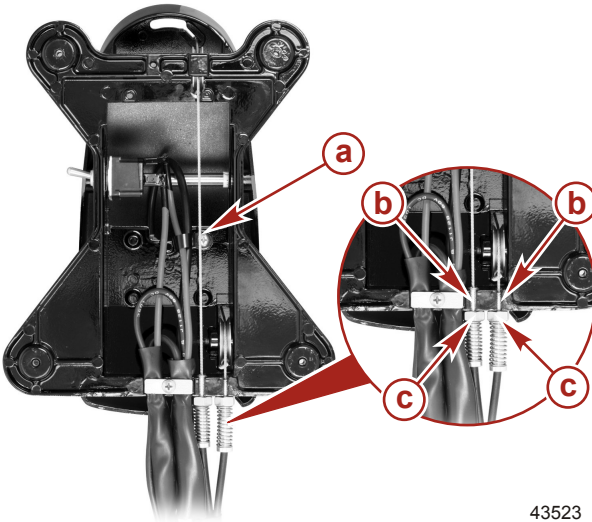

43523

- a** - Long cable tension pull point
- b** - Exposed threads of tension adjustment shafts
- c** - Cable tension adjustment nuts

Description	kilogram force	lbf
Long exposed foot pedal cable tension	9.1	20

OWNER SERVICE ASSISTANCE

Troubleshooting

NOTE: For service information, contact any certified MotorGuide service center. For a full listing of MotorGuide service centers, go to www.motorguide.com or contact any Mercury Marine Service office.

Symptom	Possible Cause	Resolution
Loss of power	Weak 12 volt trolling motor battery	Check 12 volt battery charge. Recharge or replace battery as required.
	Loose or corroded battery connections	Inspect battery connections for cleanliness and tightness.
	Propeller is loose, damaged, or off-balance	Refer to Propeller Replacement .
	Wiring or electrical connection faulty	Wire gauge from the battery to the trolling motor is insufficient. 6 gauge wire is recommended.
	Magnets cracked or chipped	The motor will whine or grind. Contact service center.
	Water intrusion in the lower unit	Contact service center.

OWNER SERVICE ASSISTANCE

Symptom	Possible Cause	Resolution
Excessive noise, vibration	Motor shaft is bent	Contact service center.
	Propeller is loose, damaged, or off-balance	Refer to Propeller Replacement .
	Damaged bearings or bushings	Contact service center.
	Magnets interfering with armature	Turn off the power and manually rotate the propeller. If the propeller does not rotate freely with a slight magnetic drag, contact service center.
	Magnets cracked or chipped	The motor will whine or grind. Contact service center.
Motor failure (motor runs at partial speed)	Electrical	Connections in the top housing may be loose or damaged. Contact service center.
	Thermal protection	Temperature exceeds specification. Contact service center.
	Damaged speed potentiometer	Contact service center.
	Propeller is loose, damaged, or off-balance	Refer to Propeller Replacement .

OWNER SERVICE ASSISTANCE

Symptom	Possible Cause	Resolution
Motor failure (motor does not run)	Weak 12 volt trolling motor battery	Check 12 volt battery charge. Recharge or replace battery as required.
	Loose or corroded battery connections	Inspect battery connections for cleanliness and tightness.
	Wiring or electrical connection faulty	Wire gauge from the battery to the trolling motor is insufficient. 6 gauge wire is recommended.
	Electrical	Check the connector for a loose or damaged connection. Contact service center.
	Thermal protection	Temperature exceeds specification. Contact service center.
	Three-position switch is damaged	Contact service center.
	Fuse on circuit breaker is open	Replace the fuse or reset the circuit breaker only after determining the root cause of the problem.
	Magnets interfering with armature	Turn off the power and manually rotate the propeller. If the propeller does not rotate freely with a slight magnetic drag, contact service center.
	Boat wiring	Contact service center.
The motor does not operate in the same direction as the directional indicator	Directional indicator misaligned	Contact service center.

OWNER SERVICE ASSISTANCE

Symptom	Possible Cause	Resolution
Inaccurate temperature reading	Lower unit not fully submerged	Adjust the depth of the motor. Ensure the lower unit is fully submerged. Refer to Adjusting the Motor Depth .
	Damaged nose cone	Contact service center.
	Damaged sonar cable	Contact service center.
Mount is hard to unlatch with the pull rope	Mount bracket is not level or twisted	Loosen or twist the two forward bracket screws slightly and latch the bracket. Continue to loosen each of the bracket screws until the bracket releases easily. If necessary, install shim washers (not supplied) and then tighten the screws. Refer to Product Installation for help.
Difficulty removing propeller	Bent propeller pin	Hold one blade and lightly tap the opposite blade with a rubber mallet.
		Use a putty knife on both sides of the propeller to apply equal pressure.
	Bent armature shaft	Contact service center.

Service Assistance

Your satisfaction with your product is very important to us. If you have a problem or question about your motor, contact your dealer or any certified MotorGuide Service Center. For more service assistance information, refer to **Warranty Information**.

The following information will be needed by the service office:

- Your name and address
- Daytime telephone number
- Model and serial number of your trolling motor
- Proof of purchase or registration verification
- Nature of problem

OWNER SERVICE ASSISTANCE

Mercury Marine Service Offices

For assistance, call, fax, or write. Please include your daytime telephone number with mail and fax correspondence.

United States, Canada		
Telephone	English - (920) 929-5040 Français - (905) 636-4751	Mercury Marine W6250 W. Pioneer Road P.O. Box 1939 Fond du Lac, WI 54936-1939
Fax	English - (920) 929-5893 Français - (905) 636-1704	
Website	www.motorguide.com	

Australia, Pacific		
Telephone	(61) (3) 9791-5822	Brunswick Asia Pacific Group 132-140 Frankston Road Dandenong, Victoria 3164 Australia
Fax	(61) (3) 9706-7228	

Europe, Middle East, Africa		
Telephone	(32) (87) 32 • 32 • 11	Brunswick Marine Europe Parc Industriel de Petit-Rechain B-4800 Verviers, Belgium
Fax	(32) (87) 31 • 19 • 65	

Mexico, Central America, South America, Caribbean		
Telephone	(954) 744-3500	Mercury Marine 11650 Interchange Circle North Miramar, FL 33025 U.S.A.
Fax	(954) 744-3535	

Brunswick Asia Pacific Group		
Telephone	(65) 65466160	T/A Mercury Marine Singapore Pte Ltd 29 Loyang Drive Singapore, 508944
Fax	(65) 65467789	